

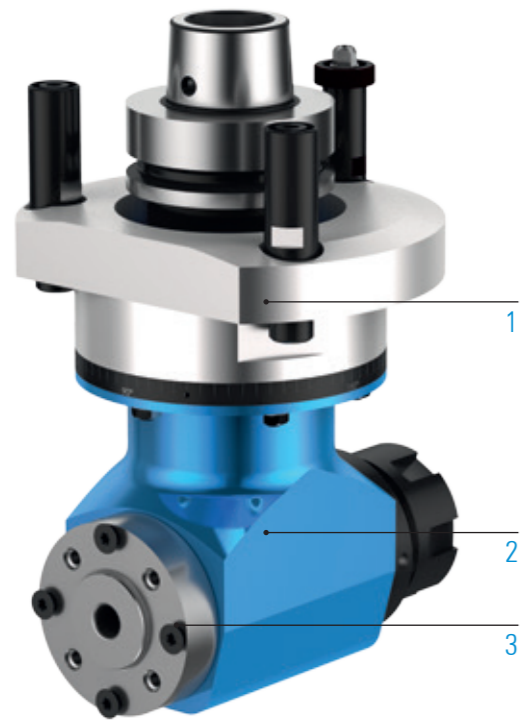



# DOUBLE SIDED ANGLE HEAD - CLASSIC LINE DUO

## TECHNICAL DATA





Lubrication Grease  
 Max. drive speed  $n_2$  15,000rpm  
 Transmission ratio ( $n_1: n_2$ ) 1:1.2  
 Max. drive torque  $M_2$  25Nm  
 Weight about 5 kg





### STANDARD DESIGN

- 1  Machine Connection  
HSK - F63
- 2  Head length  
M
- 3  Output spindle  
Collet chuck ER32  
+  
 Centring Ø30/Weldon Ø10

### MACHINING

-  Drilling
-  Milling
-  Sawing

### SPECIFICATIONS

-  Number of output spindles  
2
-  Axis angle  
90°
-  C-angle  
360°
-  Grease lubrication

### VIDEO

 Angle head - live in the application  
 Scan QR code or go to:  
[www.youtube.com/BENZWerkzeugsysteme](http://www.youtube.com/BENZWerkzeugsysteme)

### ORDER DIRECTLY

 Inquiry form:  
[www.benz-tools.de/en/products](http://www.benz-tools.de/en/products)

## ADDITIONAL OPTIONS: MODULAR DESIGN



### MACHINE CONNECTION



 For further information see p. 106



### HEAD LENGTH



 For further information see p. 107



### OUTPUT SPINDLE

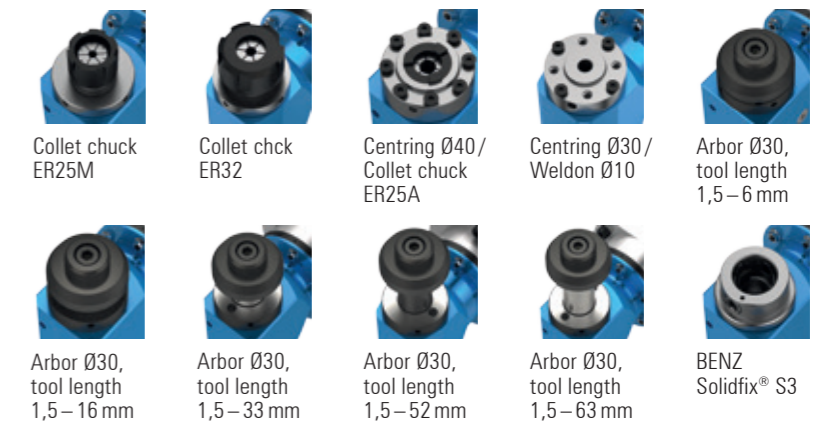

 For further information see p. 108