

HINGE MORTISING UNIT - CLASSIC LINE

CAVO V

TECHNICAL DATA

Lubrication **Grease**
 Max. drive speed n_2 **4,000rpm**
 Transmission ratio ($n_1: n_2$) **1:0.8**
 Weight **about 8 kg**

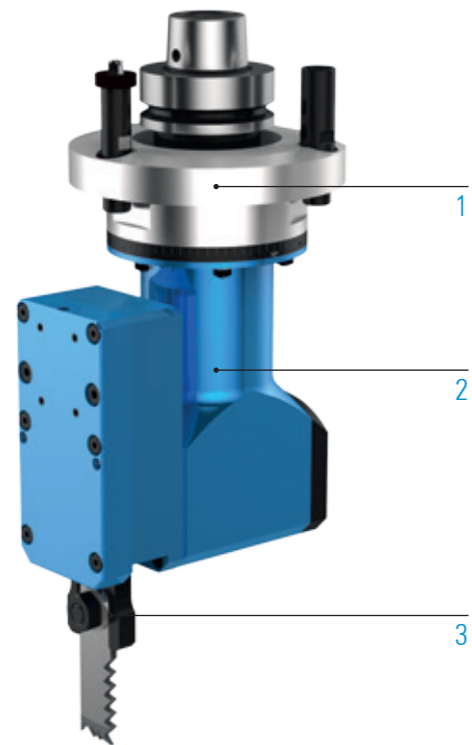

STANDARD DESIGN

- 1  Machine Connection
HSK - F63
- 2  Head length
- 3  Output spindle
Groove width 24

ADDITIONAL OPTIONS: MODULAR DESIGN

1



MACHINE CONNECTION



 For further information see p. 106

2

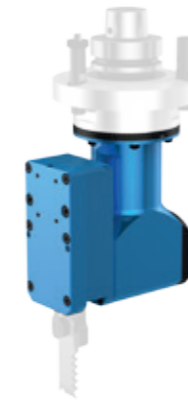

HEAD LENGTH



 For further information see p. 107

3







OUTPUT SPINDLE



MACHINING



SPECIFICATIONS

-  1 Number of output spindles
-  0° Axis angle
-  360° C-angle
-  Grease lubrication

ORDER DIRECTLY



Inquiry form:
www.benz-tools.de/en/products