

CHISEL MORTISING UNIT - CLASSIC LINE RENITO H

TECHNICAL DATA

Lubrication	Grease
Max. drive speed n_2	1,000rpm
Transmission ratio ($n_1: n_2$)	1:0.73
Max. drive torque M_2	22 Nm
Weight	about 4.5kg

STANDARD DESIGN

1  Machine Connection
HSK - F63

2  Chisel cross section
10

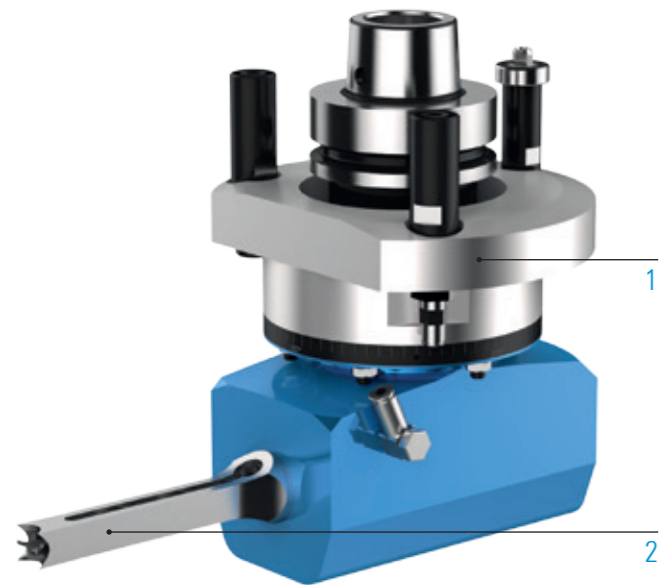

ADDITIONAL OPTIONS: MODULAR DESIGN



MACHINE CONNECTION



 For further information see p. 106

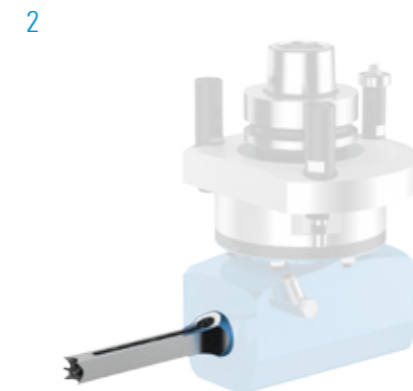

CHISEL CROSS SECTION







 Additional chisel cross sections on request

MACHINING



SPECIFICATIONS

-  Number of output spindles
-  Axis angle
-  C-angle
-  Grease lubrication

VIDEO

 Unit - live in the application
Scan QR code or go to:
www.youtube.com/BENZWerkzeugsysteme

ORDER DIRECTLY

 Inquiry form:
www.benz-tools.de/en/products